

0 600 850 103
 Stand 10-10-07
 Issue 07-01-24

Fig./Abb. 1

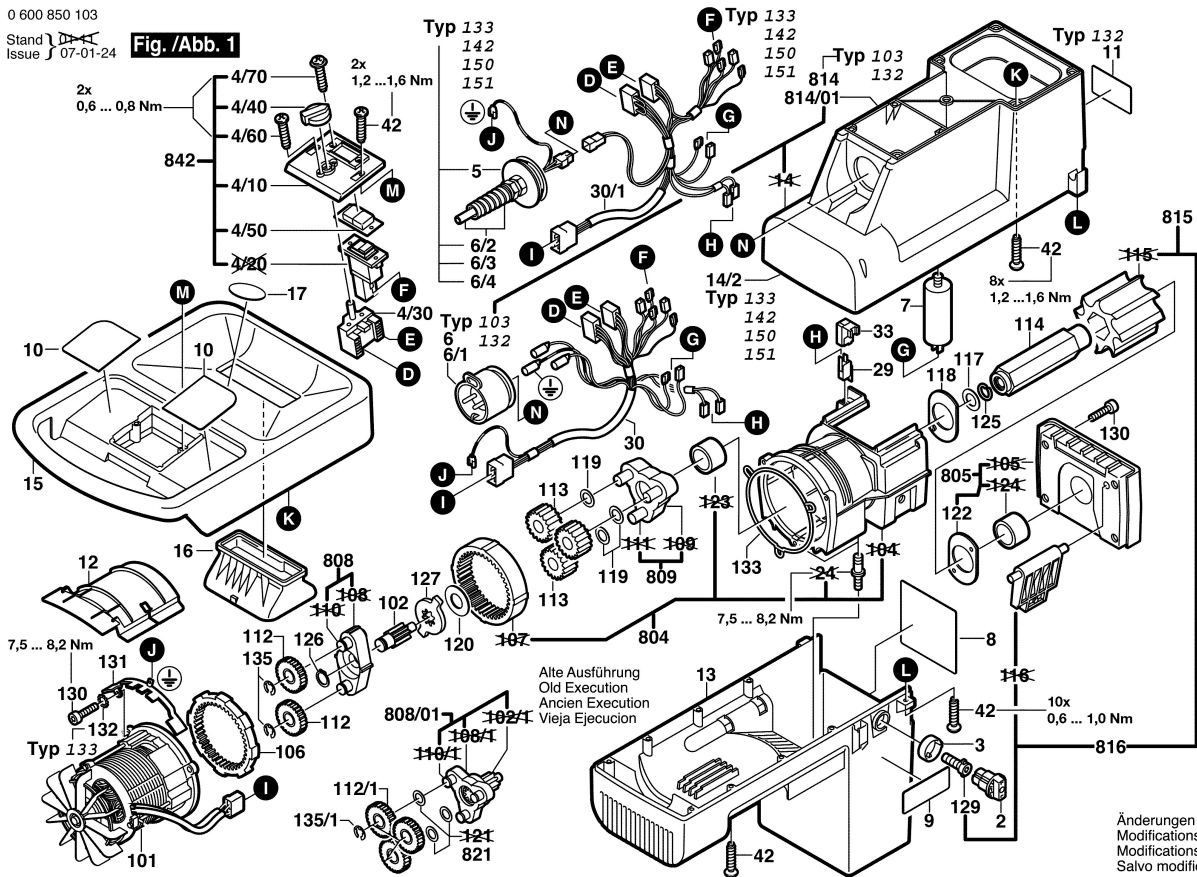

Änderungen vorbehalten
 Modifications reserved
 Modifications reserves
 Salvo modificaciones

0 600 850 103
 Stand 10-10-07
 Issue 10-10-07

Fig./Abb. 2

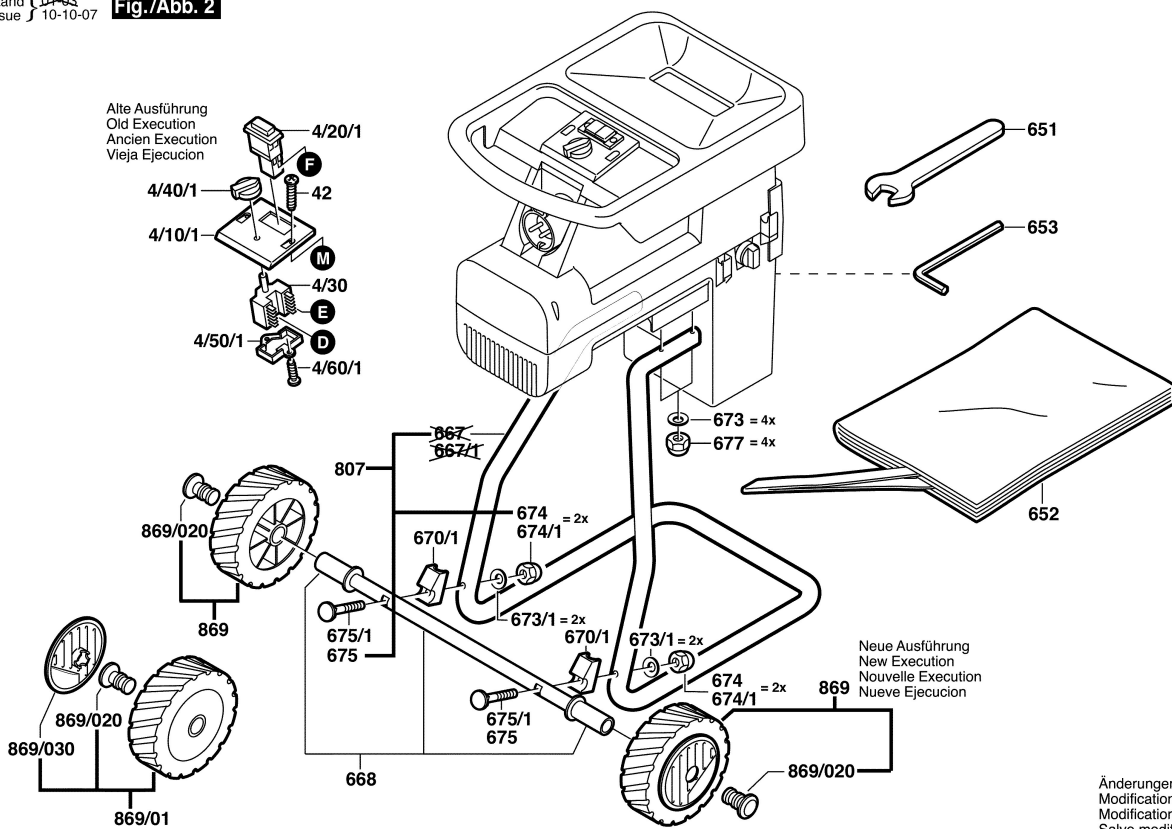

Änderungen vorbehalten
 Modifications reserved
 Modifications reserves
 Salvo modificaciones