

Type:
Part no.:

MSfo 852-1d (300Hz, 200V)
78207330260

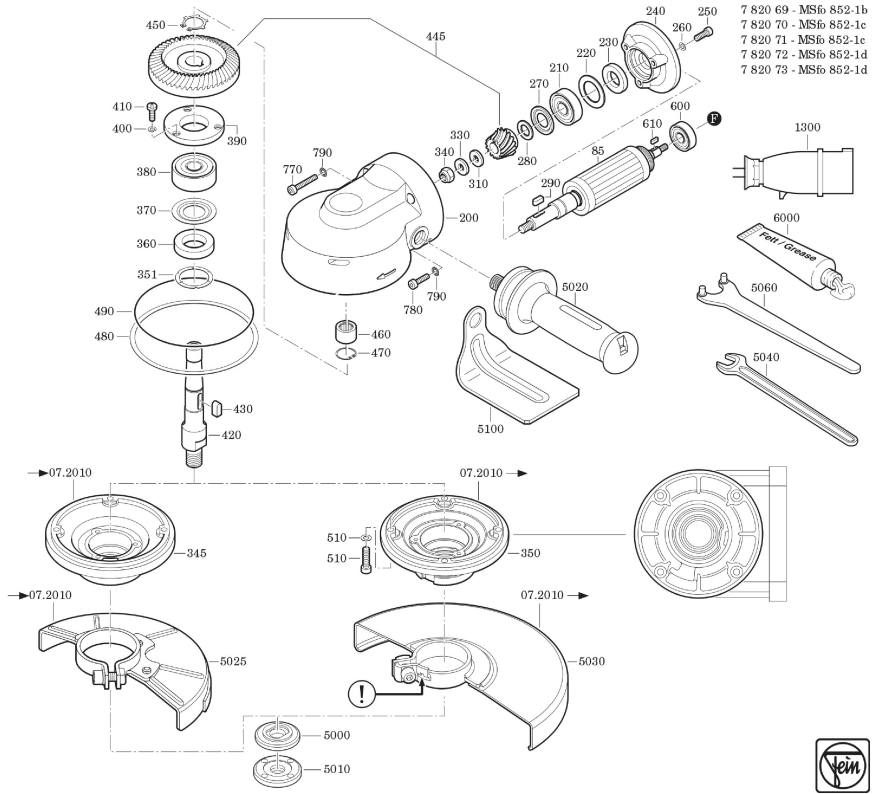

Type:
Part no.:

MSfo 852-1d (300Hz, 200V)
78207330260

