

F 013 200 045
Stand 07-01
Issue 07-04-17

Fig./Abb. 1

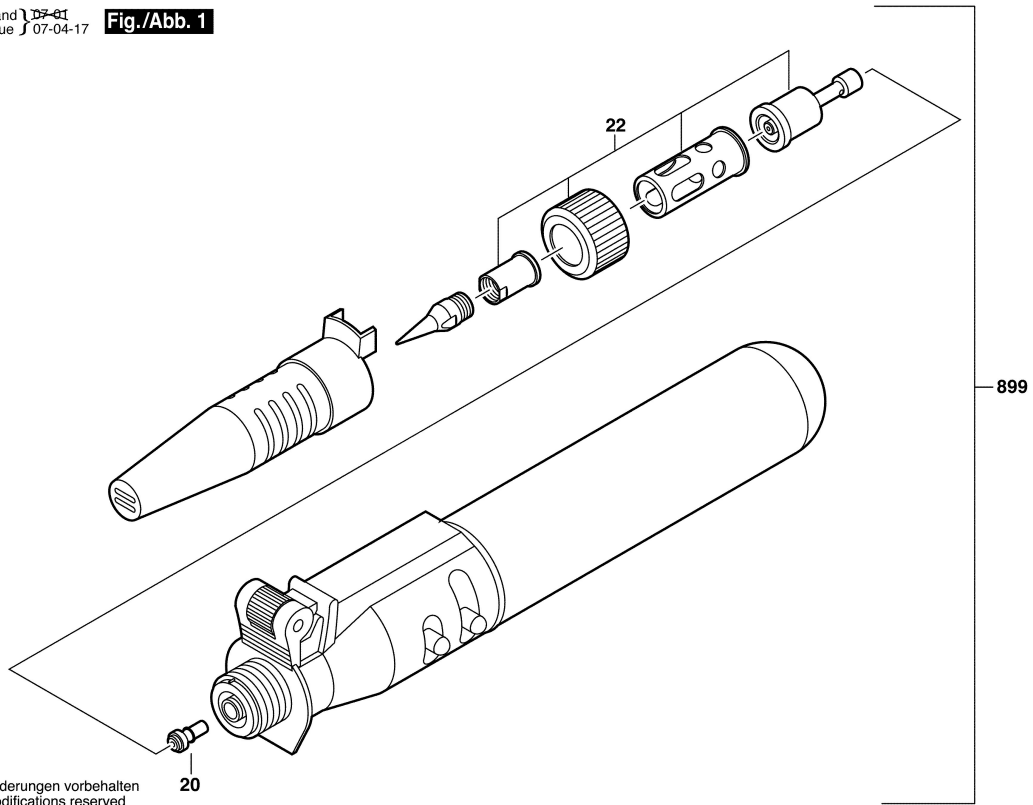

Änderungen vorbehalten
Modifications reserved
Modificacions reserves
Salvo modificaciones