

F 013 220 000

Stand } 14-07-01 **Fig. /Abb. 1**

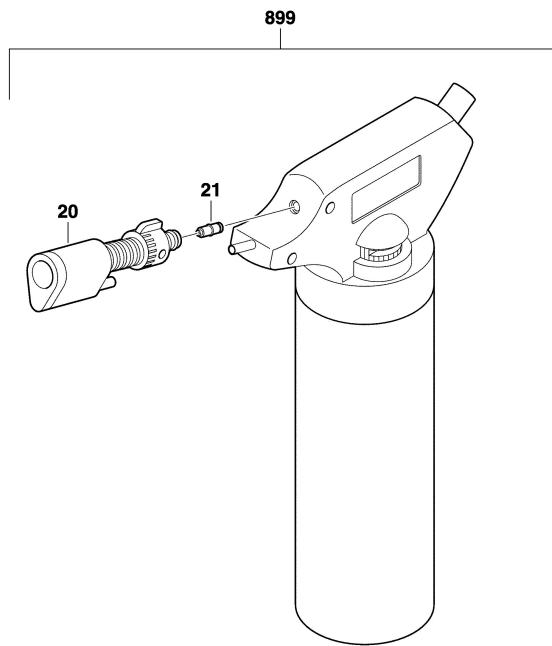

Änderungen vorbehalten
Modifications reserved
Modificacions reserves
Salvo modificaciones