

F 015 406 0A1
 Stand 38-42
 Issue 99-01-29

Fig./Abb. 1

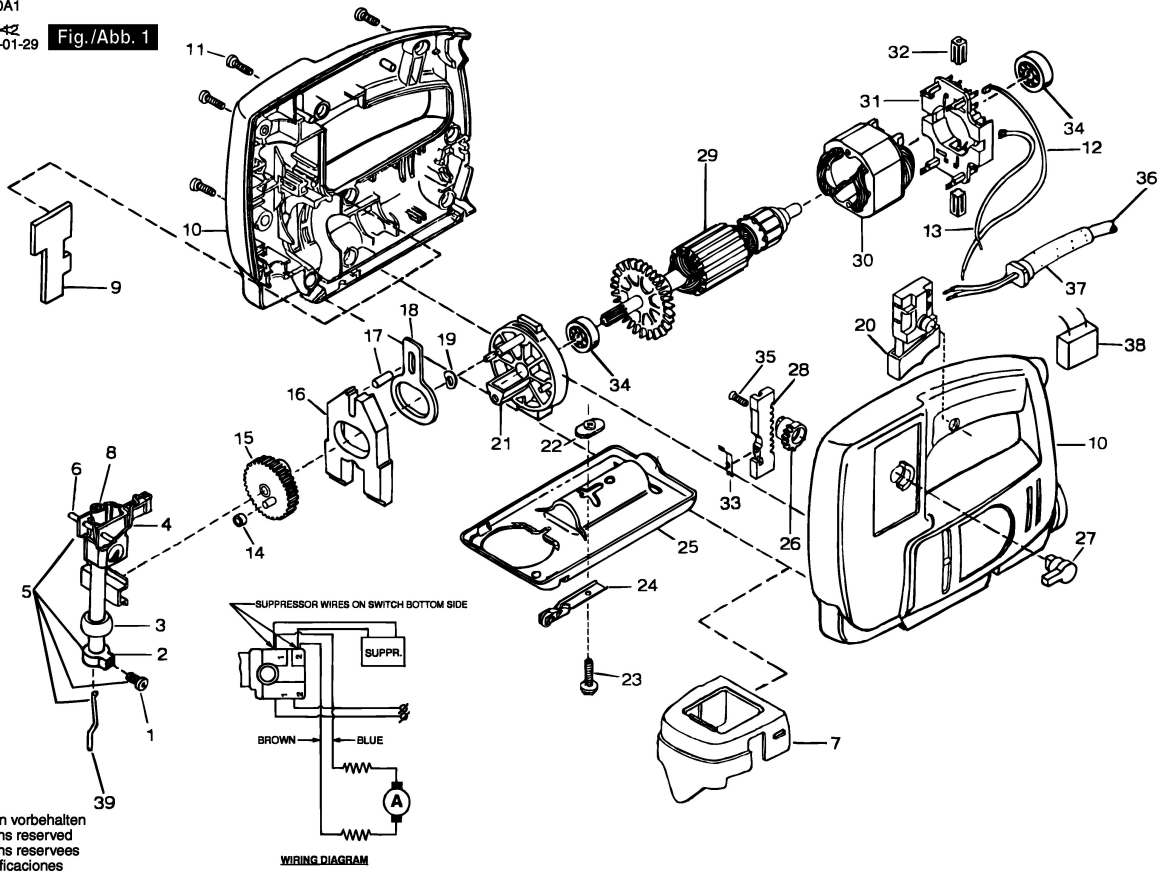

Änderungen vorbehalten
 Modifications reserved
 Modifications reserves
 Salvo modificaciones