

F 015 458 001
Stand | 07-11
Issue | 11-05-31

Fig./Abb. 1

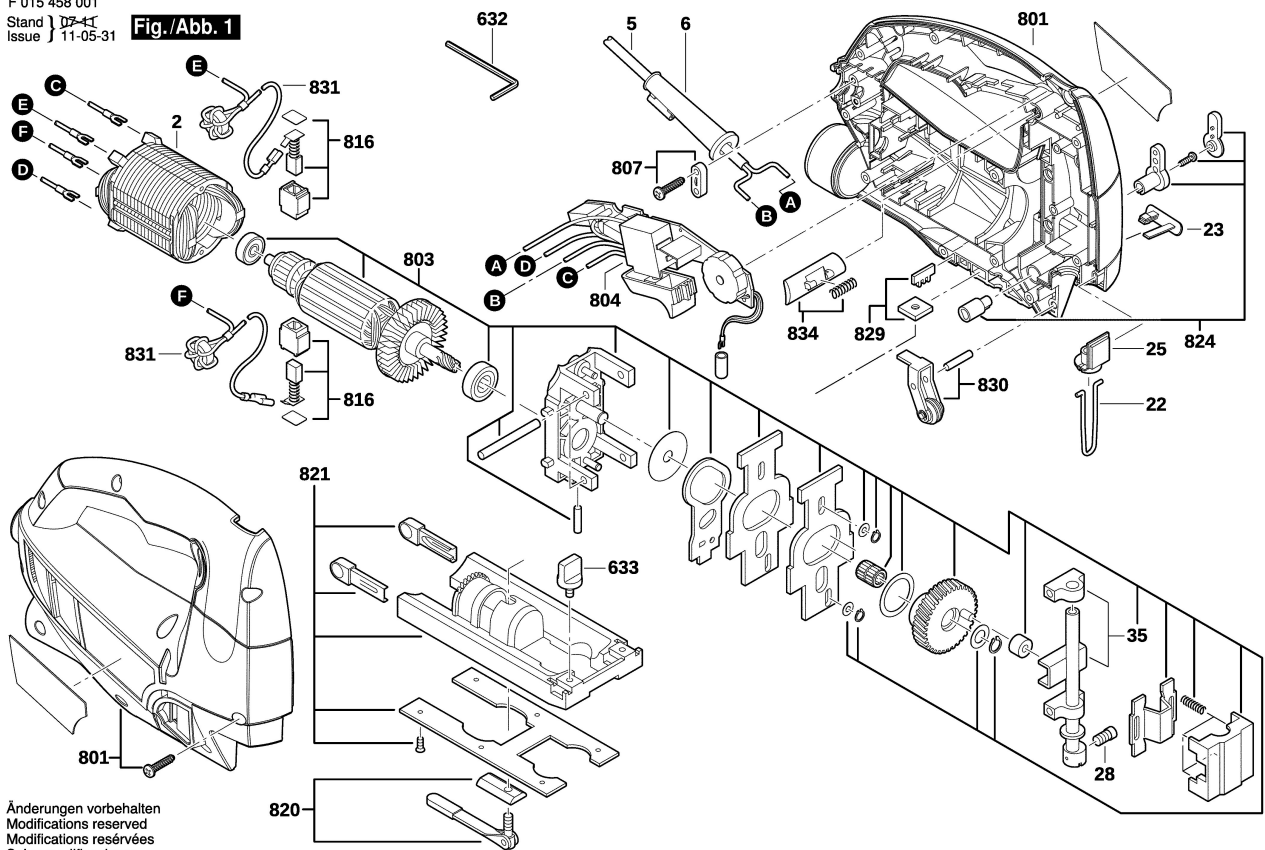

Änderungen vorbehalten
Modifications reserved
Modifications réservées
Salvo modificaciones